



# DUAL DECADE COUNTER; DUAL 4-STAGE BINARY COUNTER

The SN54/74LS390 and SN54/74LS393 each contain a pair of high-speed 4-stage ripple counters. Each half of the LS390 is partitioned into a divide-by-two section and a divide-by-five section, with a separate clock input for each section. The two sections can be connected to count in the 8.4.2.1 BCD code or they can count in a biquinary sequence to provide a square wave (50% duty cycle) at the final output.

Each half of the LS393 operates as a Modulo-16 binary divider, with the last three stages triggered in a ripple fashion. In both the LS390 and the LS393, the flip-flops are triggered by a HIGH-to-LOW transition of their CP inputs. Each half of each circuit type has a Master Reset input which responds to a HIGH signal by forcing all four outputs to the LOW state.

- Dual Versions of LS290 and LS293
- LS390 has Separate Clocks Allowing ÷2, ÷2.5, ÷5
- Individual Asynchronous Clear for Each Counter
- Typical Max Count Frequency of 50 MHz
- Input Clamp Diodes Minimize High Speed Termination Effects

## CONNECTION DIAGRAM DIP (TOP VIEW)

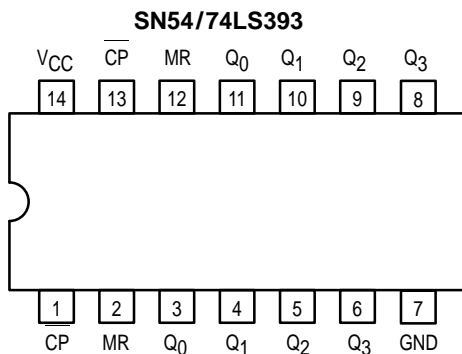
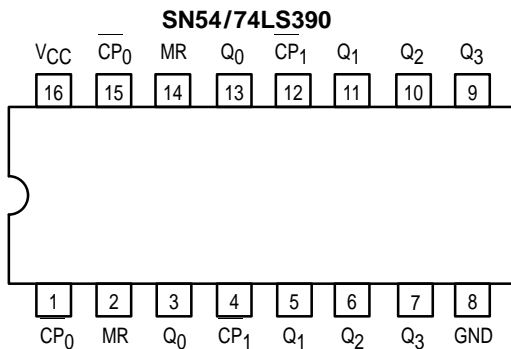

NOTE:  
The Flatpak version has the same pinouts (Connection Diagram) as the Dual In-Line Package.

## SN54/74LS390 SN54/74LS393

### DUAL DECADE COUNTER; DUAL 4-STAGE BINARY COUNTER

LOW POWER SCHOTTKY

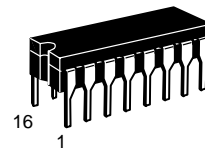

**J SUFFIX**  
CERAMIC  
CASE 620-09

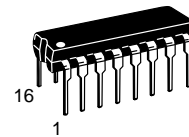

**N SUFFIX**  
PLASTIC  
CASE 648-08

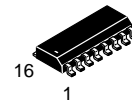

**D SUFFIX**  
SOIC  
CASE 751B-03

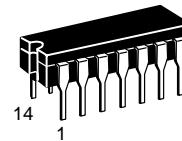

**J SUFFIX**  
CERAMIC  
CASE 632-08

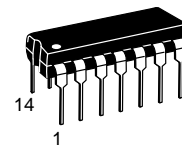

**N SUFFIX**  
PLASTIC  
CASE 646-06

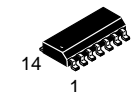

**D SUFFIX**  
SOIC  
CASE 751A-02

### ORDERING INFORMATION

SN54LSXXXJ	Ceramic
SN74LSXXXN	Plastic
SN74LSXXXD	SOIC

# SN54/74LS390 • SN54/74LS393

## PIN NAMES

$\overline{\text{CP}}$	Clock (Active LOW going edge)
	Input to +16 (LS393)
$\overline{\text{CP}}_0$	Clock (Active LOW going edge)
	Input to +2 (LS390)
$\overline{\text{CP}}_1$	Clock (Active LOW going edge)
	Input to +5 (LS390)
MR	Master Reset (Active HIGH) Input
$Q_0$ – $Q_3$	Flip-Flop outputs (Note b)

## LOADING (Note a)

	HIGH	LOW
0.5 U.L.	0.5 U.L.	1.0 U.L.
0.5 U.L.	0.5 U.L.	1.0 U.L.
0.5 U.L.	0.5 U.L.	1.5 U.L.
0.5 U.L.	0.5 U.L.	0.25 U.L.
10 U.L.	10 U.L.	5 (2.5) U.L.

## NOTES:

a) 1 TTL Unit Load (U.L.) = 40  $\mu$ A HIGH/1.6 mA LOW.

b) The Output LOW drive factor is 2.5 U.L. for Military (54) and 5 U.L. for Commercial (74) Temperature Ranges.

## FUNCTIONAL DESCRIPTION

Each half of the SN54/74LS393 operates in the Modulo 16 binary sequence, as indicated in the +16 Truth Table. The first flip-flop is triggered by HIGH-to-LOW transitions of the CP input signal. Each of the other flip-flops is triggered by a HIGH-to-LOW transition of the Q output of the preceding flip-flop. Thus state changes of the Q outputs do not occur simultaneously. This means that logic signals derived from combinations of these outputs will be subject to decoding spikes and, therefore, should not be used as clocks for other counters, registers or flip-flops. A HIGH signal on MR forces all outputs to the LOW state and prevents counting.

Each half of the LS390 contains a +5 section that is independent except for the common MR function. The +5

section operates in 4.2.1 binary sequence, as shown in the +5 Truth Table, with the third stage output exhibiting a 20% duty cycle when the input frequency is constant. To obtain a +10 function having a 50% duty cycle output, connect the input signal to CP<sub>1</sub> and connect the Q<sub>3</sub> output to the CP<sub>0</sub> input; the Q<sub>0</sub> output provides the desired 50% duty cycle output. If the input frequency is connected to CP<sub>0</sub> and the Q<sub>0</sub> output is connected to CP<sub>1</sub>, a decade divider operating in the 8.4.2.1 BCD code is obtained, as shown in the BCD Truth Table. Since the flip-flops change state asynchronously, logic signals derived from combinations of LS390 outputs are also subject to decoding spikes. A HIGH signal on MR forces all outputs LOW and prevents counting.

SN54/74LS390 LOGIC DIAGRAM (one half shown)

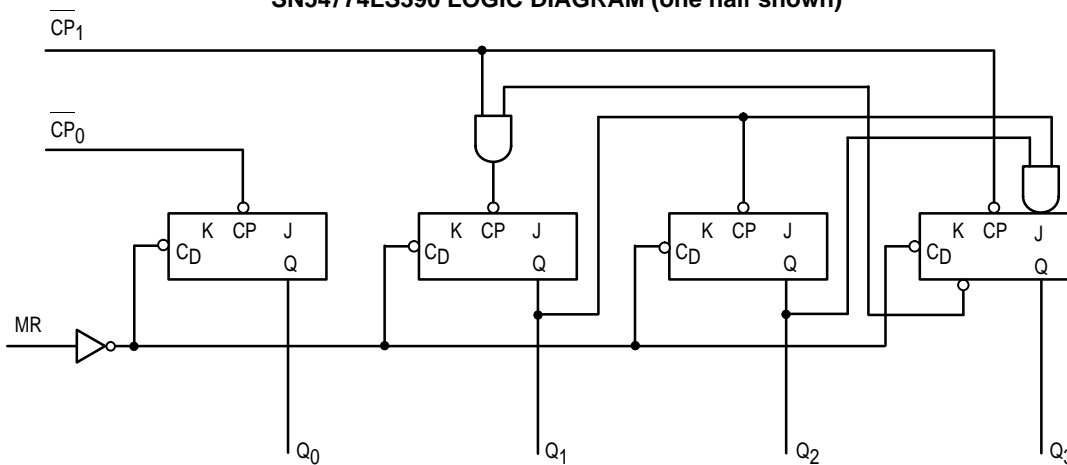

SN54/74LS393 LOGIC DIAGRAM (one half shown)

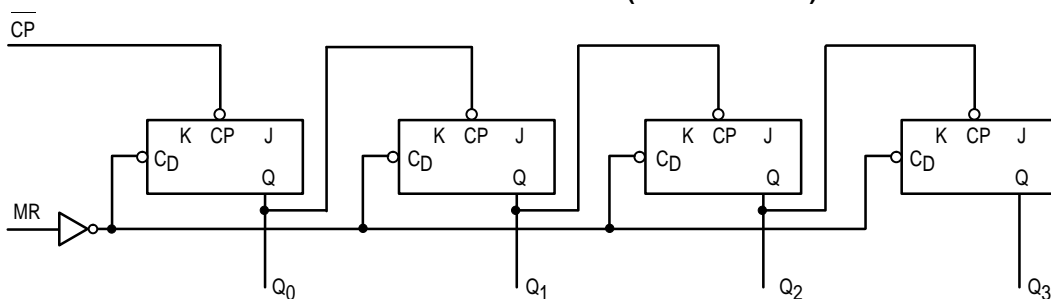

# SN54/74LS390 • SN54/74LS393

**SN54/74LS390 BCD  
TRUTH TABLE**  
(Input on CP<sub>0</sub>; Q<sub>0</sub> CP<sub>1</sub>)

COUNT	OUTPUTS			
	Q <sub>3</sub>	Q <sub>2</sub>	Q <sub>1</sub>	Q <sub>0</sub>
0	L	L	L	L
1	L	L	L	H
2	L	L	H	L
3	L	L	H	H
4	L	H	L	L
5	L	H	L	H
6	L	H	H	L
7	L	H	H	H
8	H	L	L	L
9	H	L	L	H

**SN54/74LS390 ÷ 5  
TRUTH TABLE**  
(Input on CP<sub>1</sub>)

COUNT	OUTPUTS		
	Q <sub>3</sub>	Q <sub>2</sub>	Q <sub>1</sub>
0	L	L	L
1	L	L	H
2	L	H	L
3	L	H	H
4	H	L	L

**SN54/74LS390 ÷ 10 (50% @ Q<sub>0</sub>)  
TRUTH TABLE**  
(Input on CP<sub>1</sub>, Q<sub>3</sub> to CP<sub>0</sub>)

COUNT	OUTPUTS			
	Q <sub>3</sub>	Q <sub>2</sub>	Q <sub>1</sub>	Q <sub>0</sub>
0	L	L	L	L
1	L	L	H	L
2	L	H	L	L
3	L	H	H	L
4	H	L	L	L
5	L	L	L	H
6	L	L	H	H
7	L	H	L	H
8	L	H	H	H
9	H	L	L	H

**SN54/74LS393  
TRUTH TABLE**

COUNT	OUTPUTS			
	Q <sub>3</sub>	Q <sub>2</sub>	Q <sub>1</sub>	Q <sub>0</sub>
0	L	L	L	L
1	L	L	L	H
2	L	L	H	L
3	L	L	H	H
4	L	H	L	L
5	L	H	L	H
6	L	H	H	L
7	L	H	H	H
8	H	L	L	L
9	H	L	L	H
10	H	L	H	L
11	H	L	H	H
12	H	H	L	L
13	H	H	L	H
14	H	H	H	L
15	H	H	H	H

H = HIGH Voltage Level  
L = LOW Voltage Level

## GUARANTEED OPERATING RANGES

Symbol	Parameter		Min	Typ	Max	Unit
V <sub>CC</sub>	Supply Voltage	54 74	4.5 4.75	5.0 5.0	5.5 5.25	V
T <sub>A</sub>	Operating Ambient Temperature Range	54 74	-55 0	25 25	125 70	°C
I <sub>OH</sub>	Output Current — High	54, 74			-0.4	mA
I <sub>OL</sub>	Output Current — Low	54 74			4.0 8.0	mA

# SN54/74LS390 • SN54/74LS393

## DC CHARACTERISTICS OVER OPERATING TEMPERATURE RANGE (unless otherwise specified)

Symbol	Parameter		Limits			Unit	Test Conditions	
			Min	Typ	Max			
V <sub>IH</sub>	Input HIGH Voltage		2.0			V	Guaranteed Input HIGH Voltage for All Inputs	
V <sub>IL</sub>	Input LOW Voltage	54			0.7	V	Guaranteed Input LOW Voltage for All Inputs	
		74			0.8			
V <sub>IK</sub>	Input Clamp Diode Voltage			-0.65	-1.5	V	V <sub>CC</sub> = MIN, I <sub>IN</sub> = -18 mA	
V <sub>OH</sub>	Output HIGH Voltage	54	2.5	3.5		V	V <sub>CC</sub> = MIN, I <sub>OH</sub> = MAX, V <sub>IN</sub> = V <sub>IH</sub> or V <sub>IL</sub> per Truth Table	
		74	2.7	3.5		V		
V <sub>OL</sub>	Output LOW Voltage	54, 74		0.25	0.4	V	I <sub>OL</sub> = 4.0 mA	V <sub>CC</sub> = V <sub>CC</sub> MIN, V <sub>IN</sub> = V <sub>IL</sub> or V <sub>IH</sub> per Truth Table
		74		0.35	0.5	V	I <sub>OL</sub> = 8.0 mA	
I <sub>IH</sub>	Input HIGH Current				20	μA	V <sub>CC</sub> = MAX, V <sub>IN</sub> = 2.7 V	
					0.1	mA	V <sub>CC</sub> = MAX, V <sub>IN</sub> = 7.0 V	
I <sub>IL</sub>	Input LOW Current	MR			-0.4	mA	V <sub>CC</sub> = MAX, V <sub>IN</sub> = 0.4 V	
		CP, CP <sub>0</sub>			-1.6	mA		
		CP <sub>1</sub>			-2.4	mA		
I <sub>OS</sub>	Short Circuit Current (Note 1)		-20		-100	mA	V <sub>CC</sub> = MAX	
I <sub>CC</sub>	Power Supply Current				26	mA	V <sub>CC</sub> = MAX	

Note 1: Not more than one output should be shorted at a time, nor for more than 1 second.

## AC CHARACTERISTICS (T<sub>A</sub> = 25°C, V<sub>CC</sub> = 5.0 V)

Symbol	Parameter		Limits			Unit	Test Conditions	
			Min	Typ	Max			
f <sub>MAX</sub>	Maximum Clock Frequency CP <sub>0</sub> to Q <sub>0</sub>		25	35		MHz	C <sub>L</sub> = 15 pF	
f <sub>MAX</sub>	Maximum Clock Frequency CP <sub>1</sub> to Q <sub>1</sub>		20			MHz		
t <sub>PLH</sub> t <sub>PHL</sub>	Propagation Delay, CP to Q <sub>0</sub>	LS393		12 13	20 20	ns		
t <sub>PLH</sub> t <sub>PHL</sub>	$\overline{\text{CP}}_0$ to Q <sub>0</sub>	LS390		12 13	20 20	ns		
t <sub>PLH</sub> t <sub>PHL</sub>	$\overline{\text{CP}}$ to Q <sub>3</sub>	LS393		40 40	60 60	ns		
t <sub>PLH</sub> t <sub>PHL</sub>	$\overline{\text{CP}}_0$ to Q <sub>2</sub>	LS390		37 39	60 60	ns		
t <sub>PLH</sub> t <sub>PHL</sub>	$\overline{\text{CP}}_1$ to Q <sub>1</sub>	LS390		13 14	21 21	ns		
t <sub>PLH</sub> t <sub>PHL</sub>	$\overline{\text{CP}}_1$ to Q <sub>2</sub>	LS390		24 26	39 39	ns		
t <sub>PLH</sub> t <sub>PHL</sub>	$\overline{\text{CP}}_1$ to Q <sub>3</sub>	LS390		13 14	21 21	ns		
t <sub>PHL</sub>	MR to Any Output	LS390/393		24	39	ns		

# SN54/74LS390 • SN54/74LS393

## AC SETUP REQUIREMENTS ( $T_A = 25^\circ\text{C}$ , $V_{CC} = 5.0\text{ V}$ )

Symbol	Parameter	Limits			Unit	Test Conditions
		Min	Typ	Max		
$t_W$	Clock Pulse Width LS393	20			ns	$V_{CC} = 5.0\text{ V}$
$t_W$	$CP_0$ Pulse Width LS390	20			ns	
$t_W$	$CP_1$ Pulse Width LS390	40			ns	
$t_W$	MR Pulse Width LS390/393	20			ns	
$t_{rec}$	Recovery Time LS390/393	25			ns	

## AC WAVEFORMS

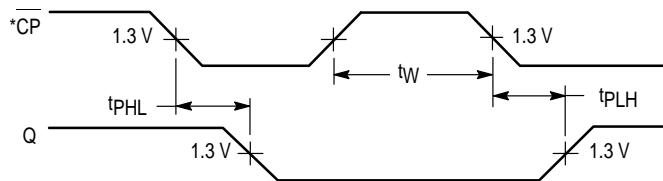

Figure 1

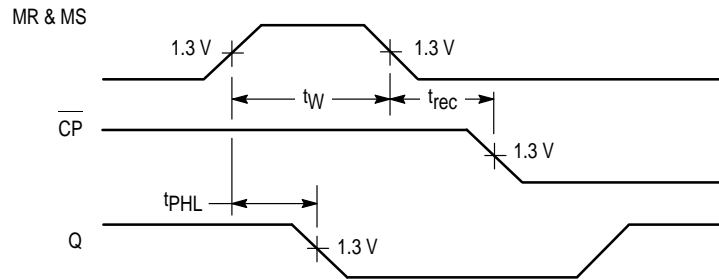

Figure 2

\*The number of Clock Pulses required between  $t_{PHL}$  and  $t_{PLH}$  measurements can be determined from the appropriate Truth Table.